



## COVID-19 SISTEMI DI PROTEZIONE

PARAFIATI FREESTANDING | BARRIERE PER BANCONI E SCRIVANIE

STAND MONOPOSTAZIONE | ACCESSORI E SEGNALETICA

PROGETTI SU MISURA



**LINEA PARAFIATI**  
BARRIERE PROTETTIVE  
PER ESERCIZI PUBBLICI

# MOD. HMM01

3 MISURE | RENDIRESTO INTEGRATO | PERSONALIZZABILE

HMM01 - LARGE

HMM01 - MEDIUM

HMM01 - SMALL



RENDIRESTO DISPONIBILE  
ANCHE IN FOREX  
BIANCO O STAMPATO

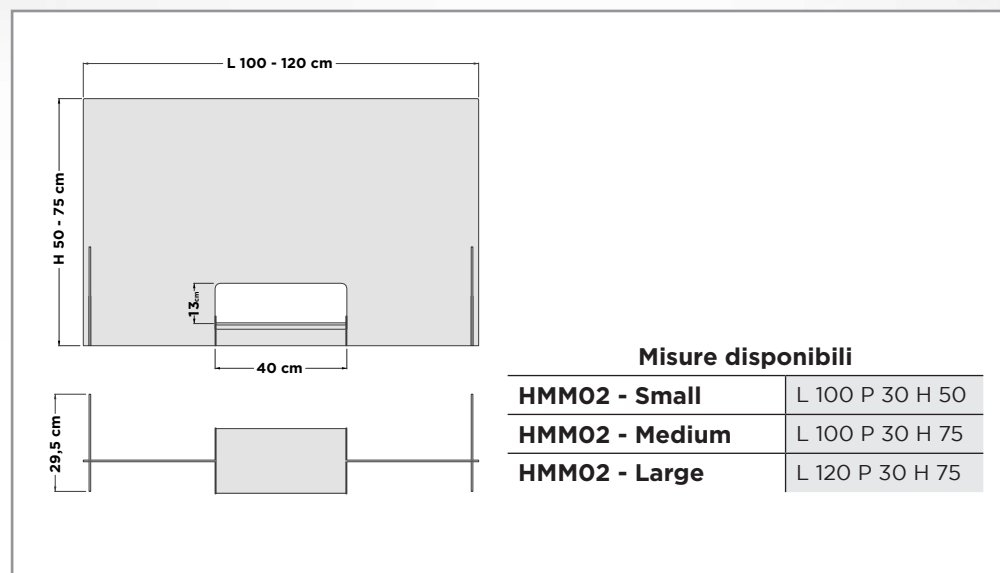

### Misure disponibili

HMM02 - Small	L 100 P 30 H 50
HMM02 - Medium	L 100 P 30 H 75
HMM02 - Large	L 120 P 30 H 75

# MOD. HMM02

3 MISURE | RENDIRESTO OPZIONALE | PERSONALIZZABILE

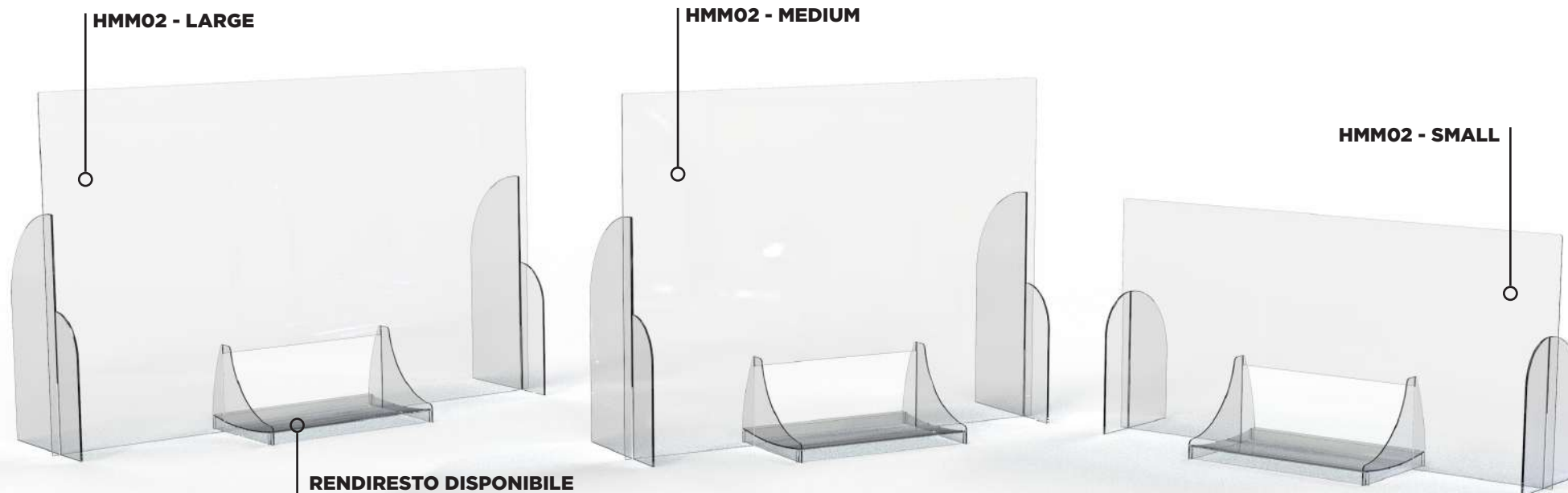

HMM02 - LARGE

HMM02 - MEDIUM

HMM02 - SMALL

**RENDIRESTO DISPONIBILE  
ANCHE IN FOREX  
BIANCO O STAMPATO**

## MOD. HMM02

OPZIONE SENZA RENDIRESTO

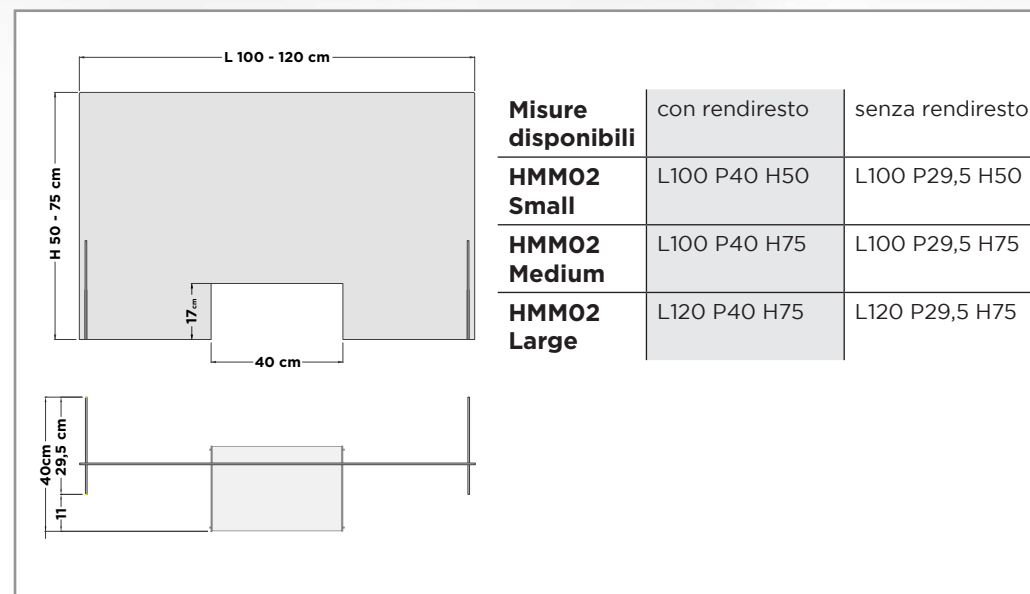
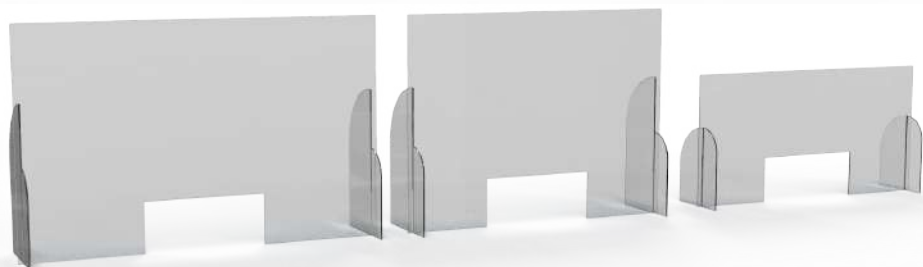

# MOD. HMM03

2 MISURE | RENDIRESTO OPZIONALE | PERSONALIZZABILE



## MOD. HMM03

OPZIONE SENZA RENDIRESTO

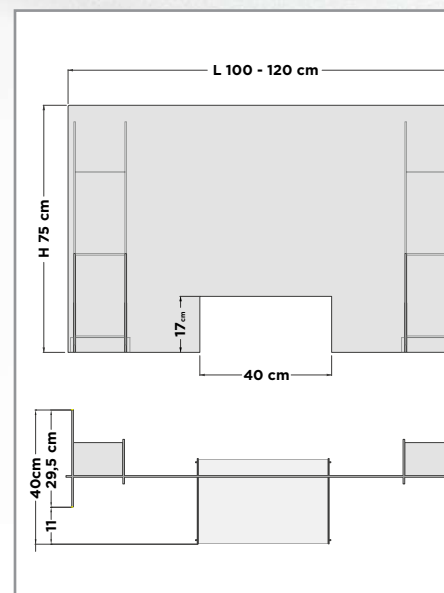

### Misure disponibili

**HMM03 Single SX/DX**

**HMM03 Double**

	con rendiresto	senza rendiresto
HMM03 Single SX/DX	L100 P40 H75	L100 P29,5 H75
HMM03 Double	L120 P40 H75	L120 P29,5 H75

# MOD. HMM04

SISTEMA MODULARE CON AGGANCIAMENTO TELESCOPICO

## IL BANCO DEL TUO ESERCIZIO COMMERCIALE HA UNA FORMA IRREGOLARE?

NESSUN PROBLEMA! IL SISTEMA **HMM04** SI AGGANCIAMO AL BANCO TRAMITE DELLE **STAFFE TELESCOPICHE ESTENDIBILI!**

- **Modello da 40 a 70 cm**
- **Modello da 70 a 120 cm**

### STAFFE TELESCOPICHE SEMPLICI DA INSTALLARE

DISPONIBILI NEI COLORI:

- BIANCO LUCIDO
- NERO LUCIDO
- ANTRACITE LUCIDO

È POSSIBILE AVERLE  
IN **ACCIAIO INOX**  
SU ORDINAZIONE

SCEGLI LA FORMA DI  
PARAFIATO PIÙ ADATTA  
ALLE TUE ESIGENZE

MISURE DEI PANNELLI:  
Larghezza 80, 100 o 120 cm  
Altezza 50 o 75 cm

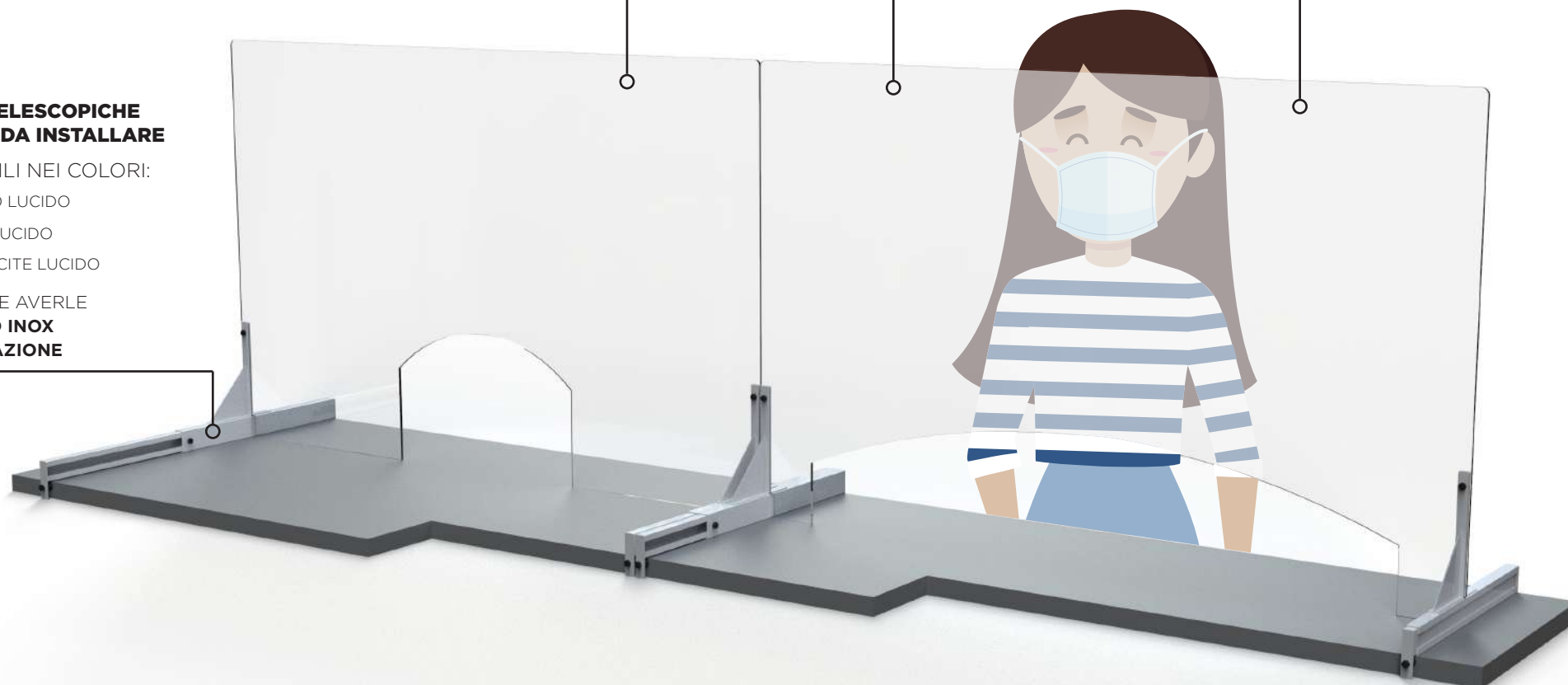

# PERSONALIZZAZIONI DISPONIBILI

LE GRAFICHE SONO APPLICABILI SU TUTTI I MODELLI



## AREE PERSONALIZZABILI

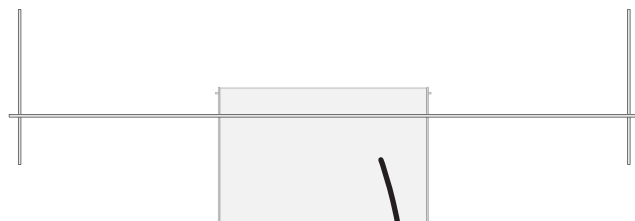

## GRAFICA 1 - DOTTED

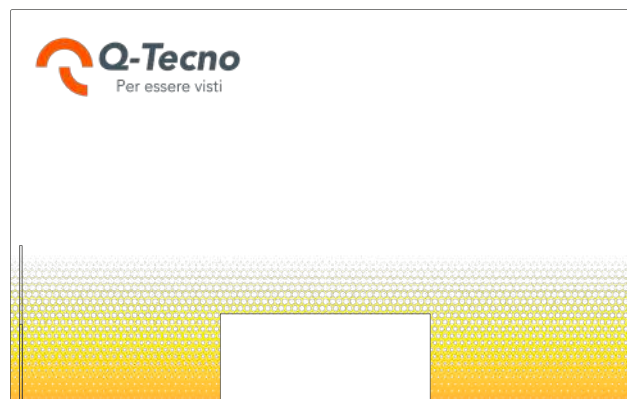

## GRAFICA 2 - FLORAL

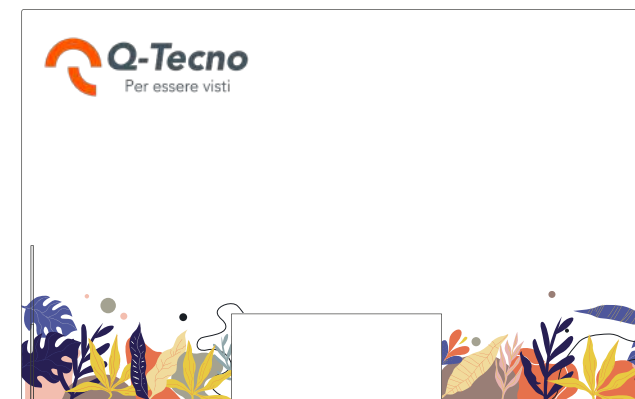

## RENDIRESTO

STAMPA A COLORI



Le grafiche qui riportate sono disponibili e personalizzabili a seconda delle esigenze.

**È inoltre possibile richiedere delle personalizzazioni aggiuntive. Il nostro team ti fornirà il supporto dal punto di vista grafico.**



# PROGETTO PERSONALIZZATO

UN PROGETTO SU MISURA PER IL TUO NEGOZIO



IL TUO  
LOGO

**CERCHI UNA  
SOLUZIONE SU MISURA  
PER IL TUO NEGOZIO?  
CI PENSIAMO NOI!**

UN NOSTRO  
OPERATORE VERRÀ  
DA TE PER UN  
SOPRALLUOGO E TI  
VERRÀ SOTTOPOSTO  
UN PROGETTO  
ADEGUATO ALLE TUE  
NECESSITÀ!

**CONTATTACI:  
+41 91 646 32 46**





## **LINEA SEPARÈ**

DIVISORI  
PROTETTIVI  
PER LUOGHI  
PUBBLICI  
E UFFICI

# SEPARÈ MODULARE BIFRONTALE

SCHEMI PARAFIATO PER SCRIVANIE

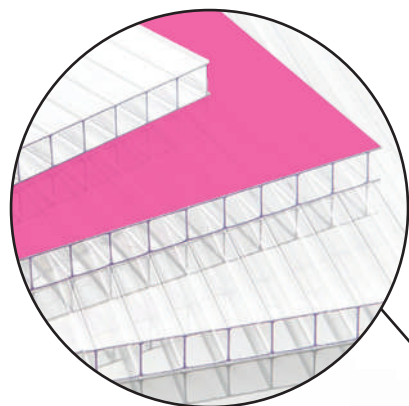

**POLICARBONATO ALVEOLARE DA 1 cm**  
**POSSIBILITÀ DI STAMPA**  
integrale a 1 colore o personalizzata

**PUOI PERSONALIZZARE I SEPARÈ COME PREFERISCI:**  
**STAMPATI AD 1 COLORE**  
**OPPURE PERSONALIZZATI CON IL TUO LOGO O UNA GRAFICA**

**SISTEMA MODULARE A INCASTRO.**  
**ESPANDIBILE A SECONDA DELLE TUE NECESSITÀ**

## MODULI DISPONIBILI

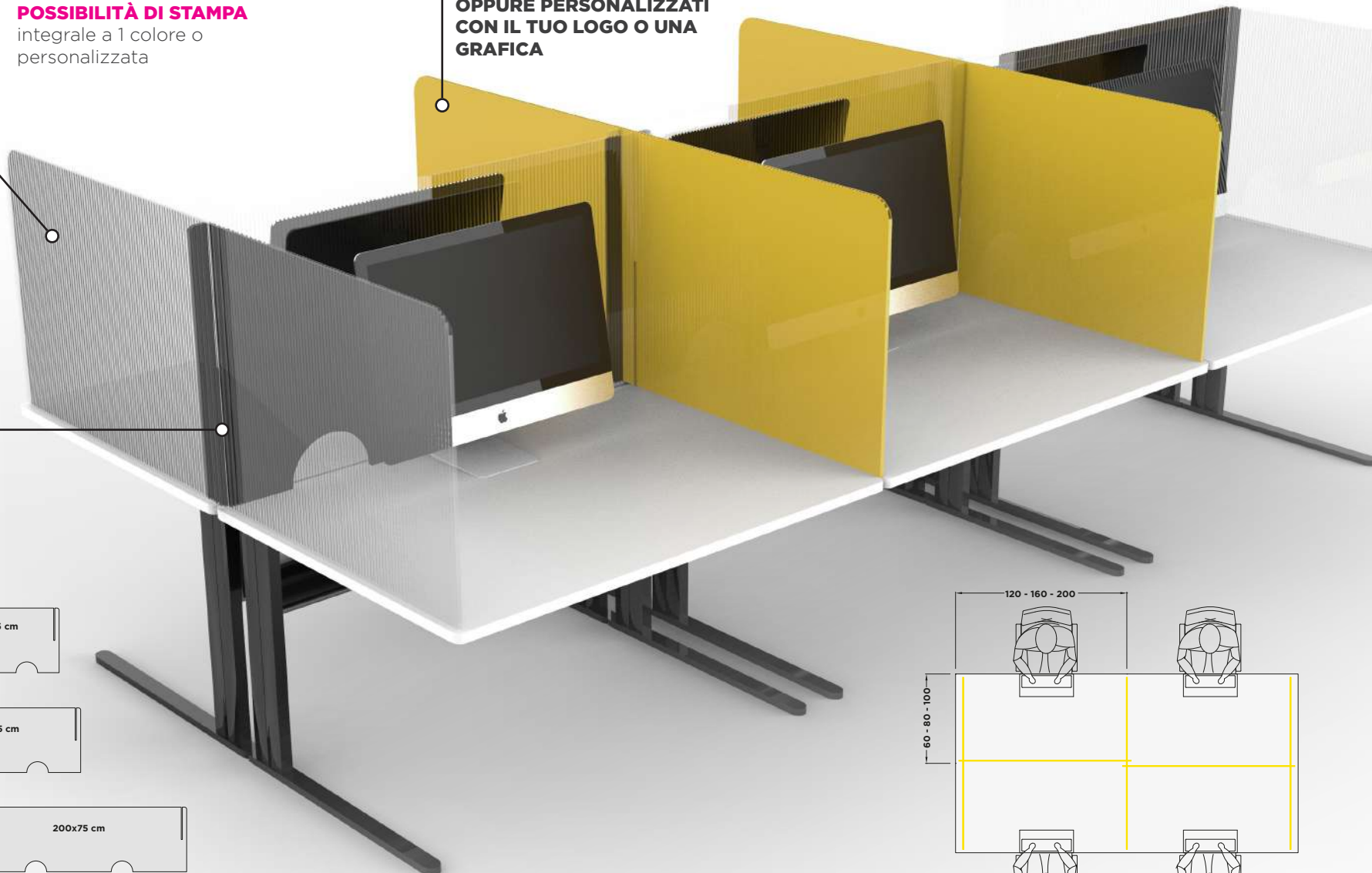
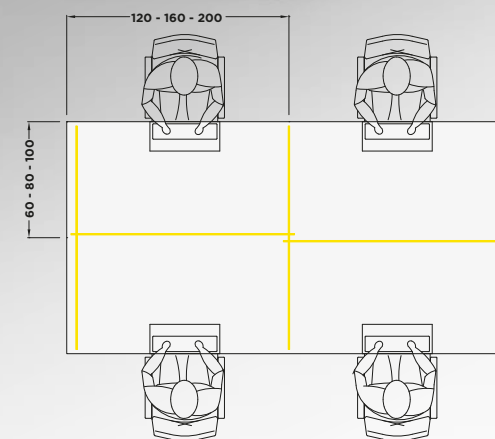

# SCHERMI DIVISORI MODULARI

POLICARBONATO ALVEOLARE | PERSONALIZZABILE



## SCHERMI DIVISORI PER TAVOLI, SCRIVANIE E BANCONI.

**FREESTANDING O CON MORSETTO A VITE.**

Misure: L 40-60-80 H 75 cm

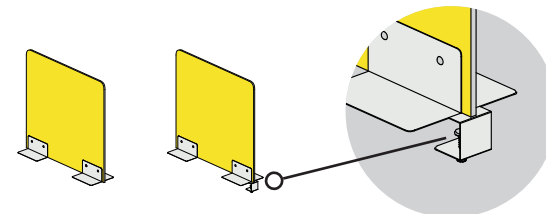

## SCHERMI DIVISORI DA TERRA componibili.

**GIUNTA LINEARE, A 45° O A 90°.**

Misure: L 60-75 H 150-200 cm

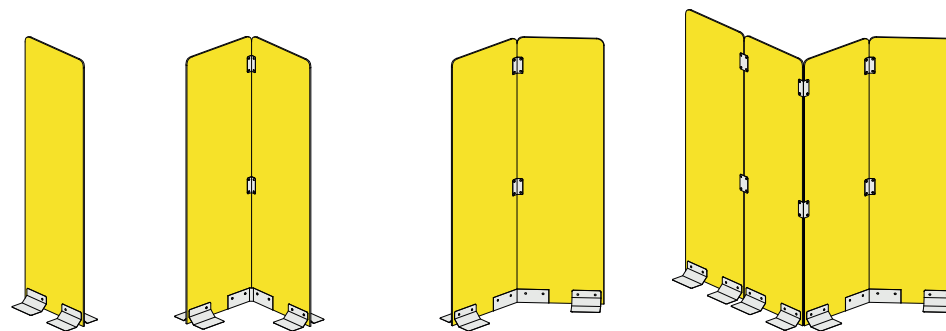

## SOLUZIONI COMBINATE PER TAVOLI, SCRIVANIE, SPORTELLI E BANCONI.

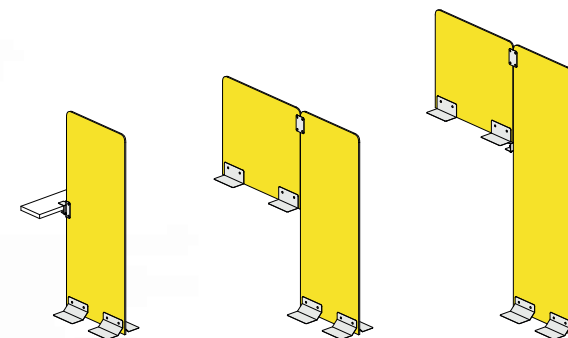



# PROGETTO PERSONALIZZATO

UN PROGETTO SU MISURA PER IL TUO NEGOZIO



**CERCHI UNA  
SOLUZIONE  
SU MISURA?  
CI PENSIAMO NOI!**

UN NOSTRO  
OPERATORE VERRÀ  
DA TE PER UN  
SOPRALLUOGO E TI  
VERRÀ SOTTOPOSTO  
UN PROGETTO  
ADEGUATO ALLE TUE  
NECESSITÀ!

**CONTATTACI:  
+41 91 646 32 46**

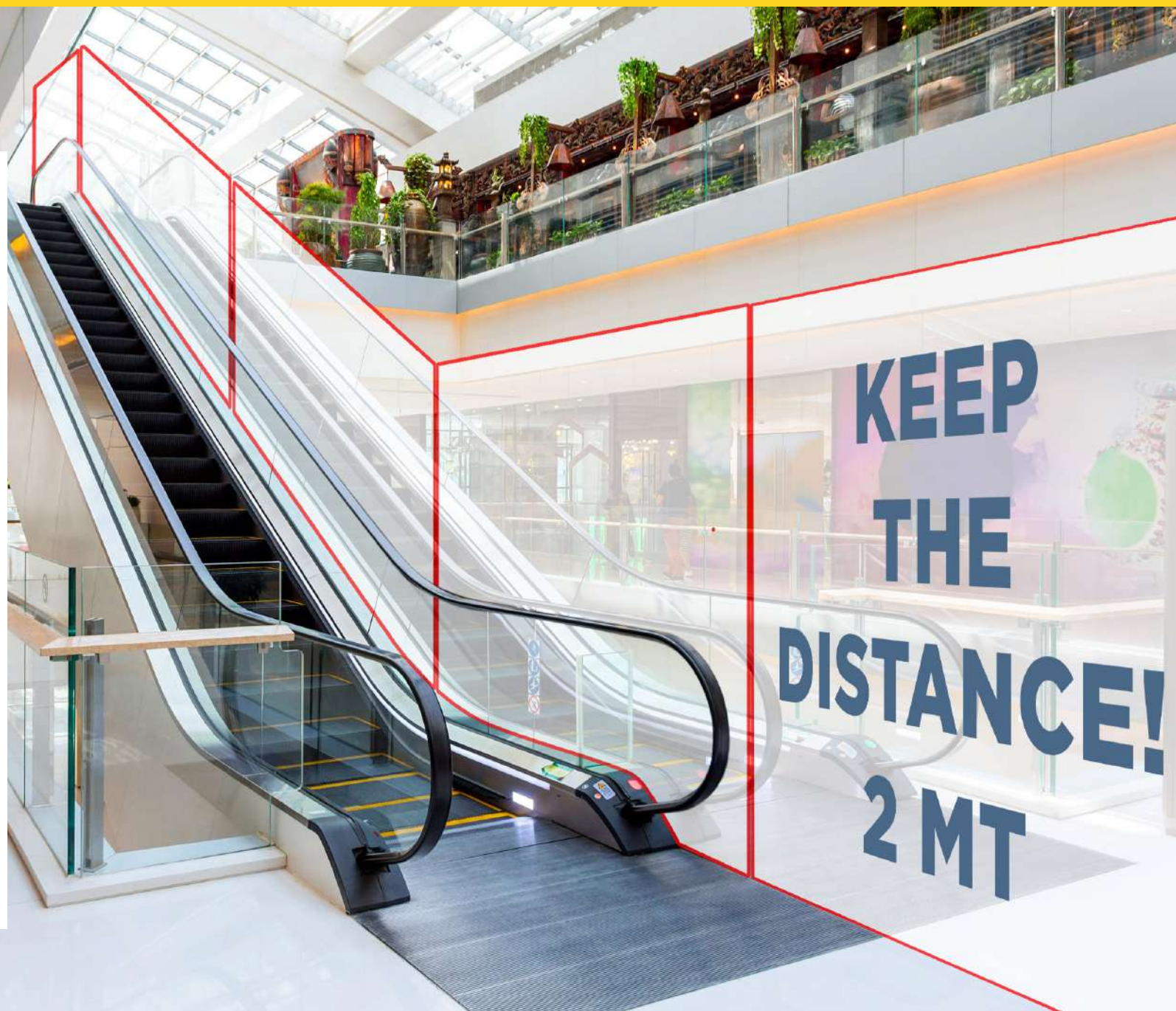





**IL TUO LOGO**



**GRAFICA  
PERSONALIZZABILE**



**STAND  
MONOPOSTAZIONE**

# STAND EXPO MOD. FULL

STRUTTURA IN FERRO, COPERTURA IN FOREX, SCHERMO IN PLEXIGLASS



**POSTAZIONE TEMPORANEA PER OPERATORE COMPLETA DI SCHERMO DI PROTEZIONE, PERSONALIZZABILE.**

**IDEALE PER ESERCIZI COMMERCIALI O UFFICI PUBBLICI.**

**MENSOLE POSTERIORI**

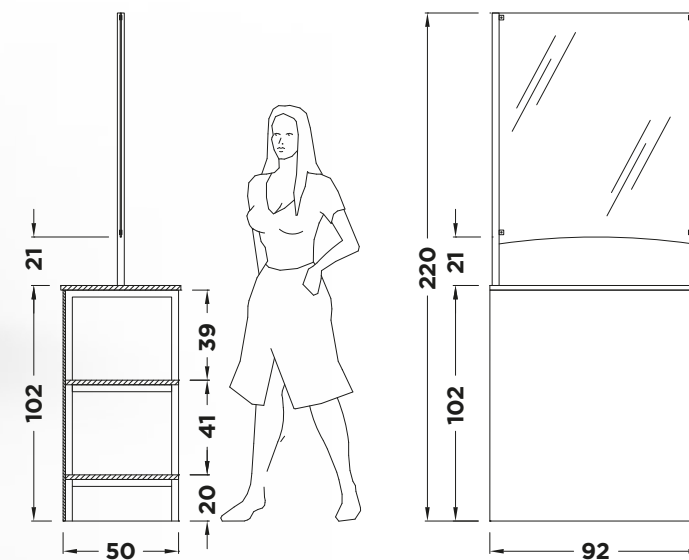

# STAND EXPO MOD. EASY

STRUTTURA IN FERRO, COPERTURA IN FOREX, SCHERMO IN PLEXIGLASS



**POSTAZIONE TEMPORANEA PER  
OPERATORE COMPLETA DI SCHERMO  
DI PROTEZIONE,  
PERSONALIZZABILE.**

**IDEALE PER ESERCIZI COMMERCIALI  
O UFFICI PUBBLICI.**

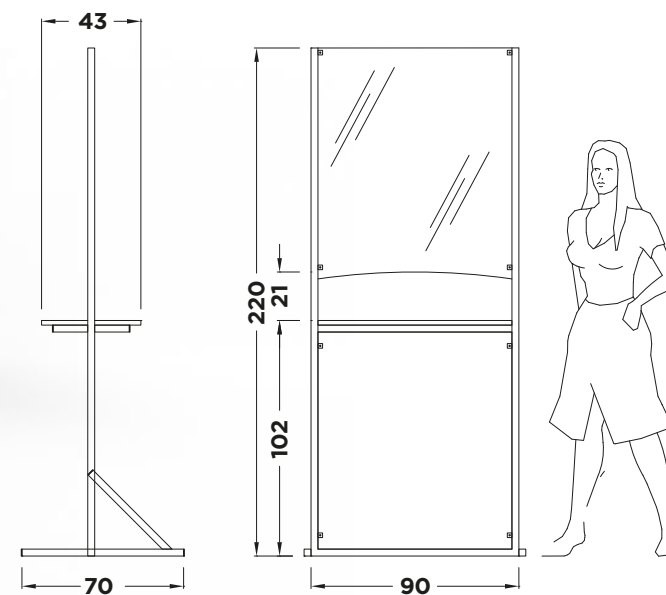



# PROGETTO PERSONALIZZATO

UN PROGETTO SU MISURA PER IL TUO NEGOZIO

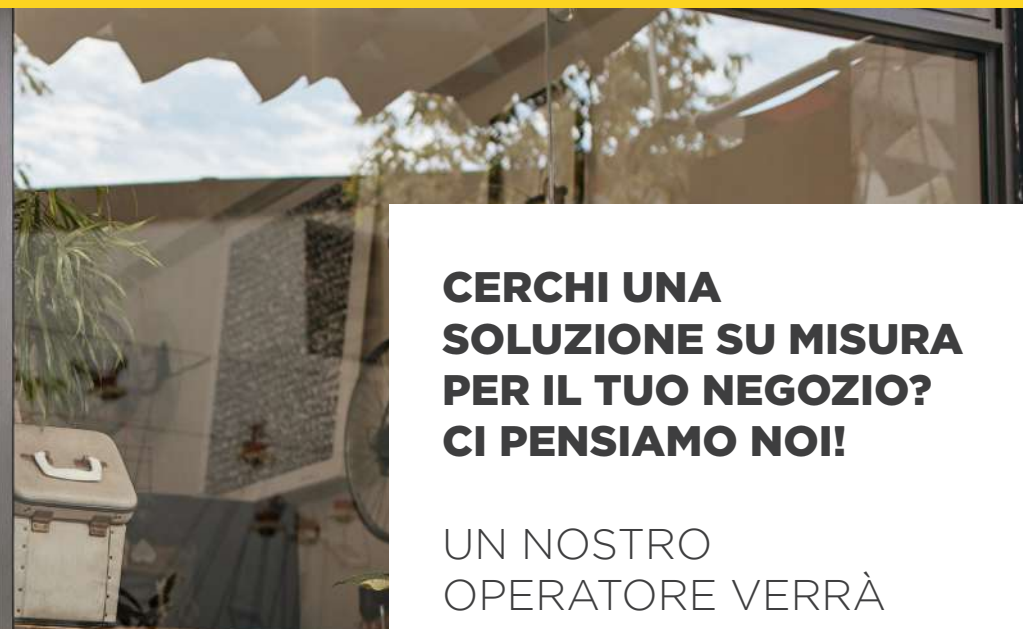

**CERCHI UNA  
SOLUZIONE SU MISURA  
PER IL TUO NEGOZIO?  
CI PENSIAMO NOI!**

UN NOSTRO  
OPERATORE VERRÀ  
DA TE PER UN  
SOPRALLUOGO E TI  
VERRÀ SOTTOPOSTO  
UN PROGETTO  
ADEGUATO ALLE TUE  
NECESSITÀ!

**CONTATTACI:  
+41 91 646 32 46**





**ACCESSORI**



100 x 15 cm



colore personalizzabile



100 x 8 cm



colore personalizzabile



100 x 15 cm

colore personalizzabile



50 x 44 cm  
colore personalizzabile

**PERSONALIZZABILI A SECONDA DELLE TUE NECESSITÀ!**

**IDEALE PER ESERCIZI COMMERCIALI O UFFICI PUBBLICI.**

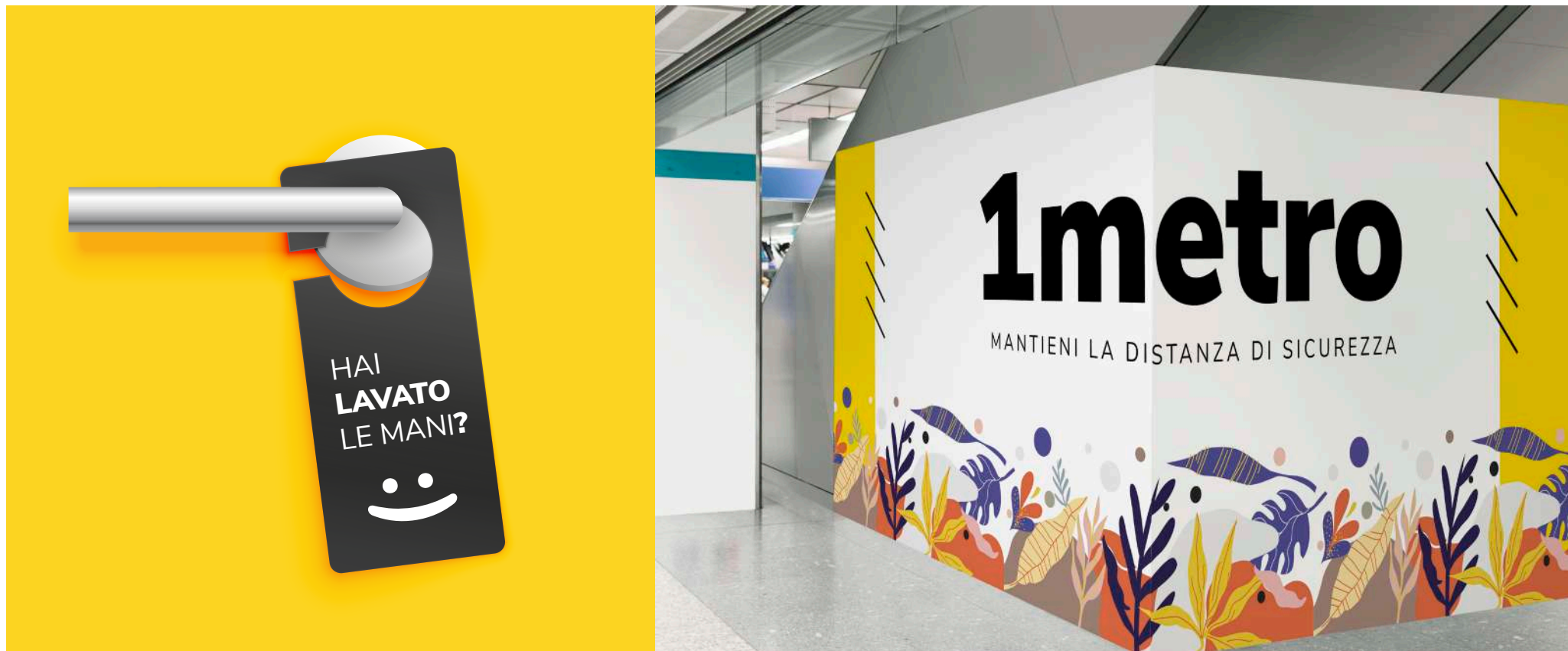

**PERSONALIZZABILI A SECONDA DELLE TUE NECESSITÀ!**

**IDEALI PER ESERCIZI COMMERCIALI O UFFICI PUBBLICI.**

**MATERIALI DISPONIBILI: FOREX, POLICARBONATO, PANNELLO PIUMA E ALLUMINIO DIBOND.**



**Q-TECNO SA**

**[www.qtecno.com](http://www.qtecno.com) - +41 91 646 32 46**

Piazzale Roncà 4, 6850 Mendrisio